

Frigerio

EDDIE SMALL TABLE

Design R&D Frigerio

Elegante e dalle proporzioni calibrate, il tavolino Eddie è stato concepito per abbinarsi perfettamente al divano della stessa famiglia, in continuità con le sue linee orizzontali. Il tavolino per soggiorno Eddie è configurabile come elemento terminale con un doppio piano d'appoggio con scaffali libreria laterali. Segni sottili che disegnano spazi aperti come contrappunti ai volumi generosi del divano a cui si ispira. Il tavolino Eddie, in legno di frassino e colori laccati lucido, può essere utilizzato anche fronte divano come elemento in libero posizionamento.

Elegant and with balanced proportions, the Eddie small table is designed to match perfectly with the sofa of the same family, in continuity with its horizontal lines. The living room coffee table Eddie is set up as a double-top end element with side bookcase shelves compartments. Subtle signs that draw open spaces as counterpoints to the generous volumes of the sofa by which it is inspired. The Eddie small table table, in ash wood and glossy lacquer colors, can also be used as free-standing element in the middle of the room.

Struttura: impiallacciato frassino color Tabacco, color Wengé, color Greige, color Sabbia o color Liquirizia, oppure laccato lucido.

Structure: veneered ashwood colour Tobacco, colour Wengé, colour Greige, colour Sand or colour Liquorice; or lacquered glossy colour.



EDDIE SMALL TABLE

Design R&D Frigerio

TAVOLINI / SMALL TABLES

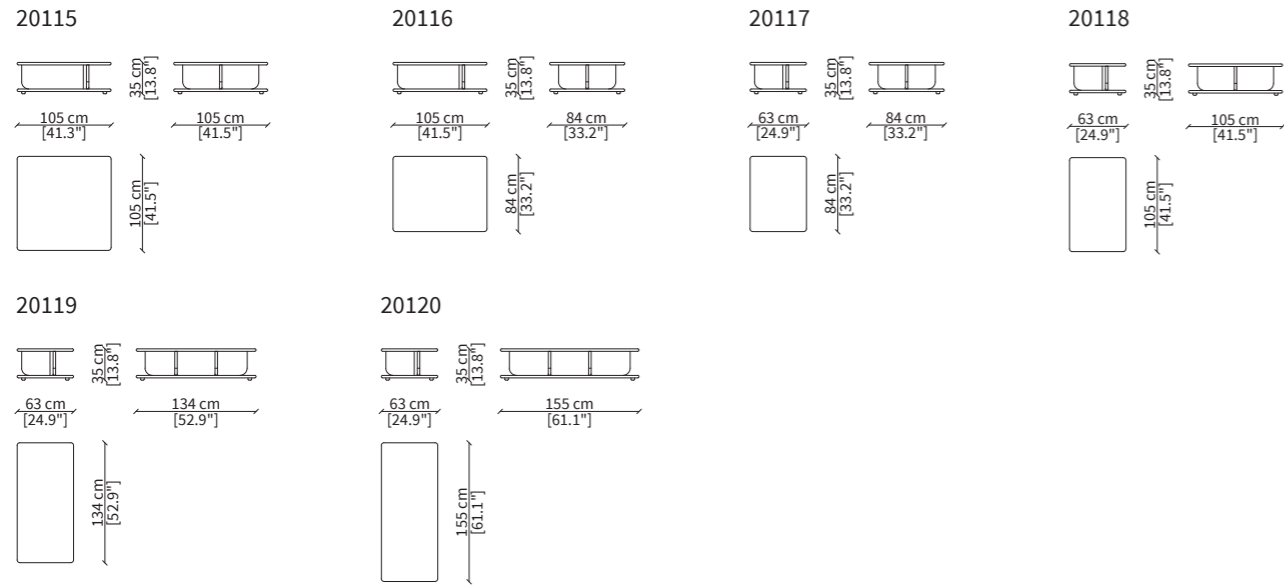

ALTRI ELEMENTI DELLA FAMIGLIA / OTHER ELEMENTS OF THE FAMILY / POUFS

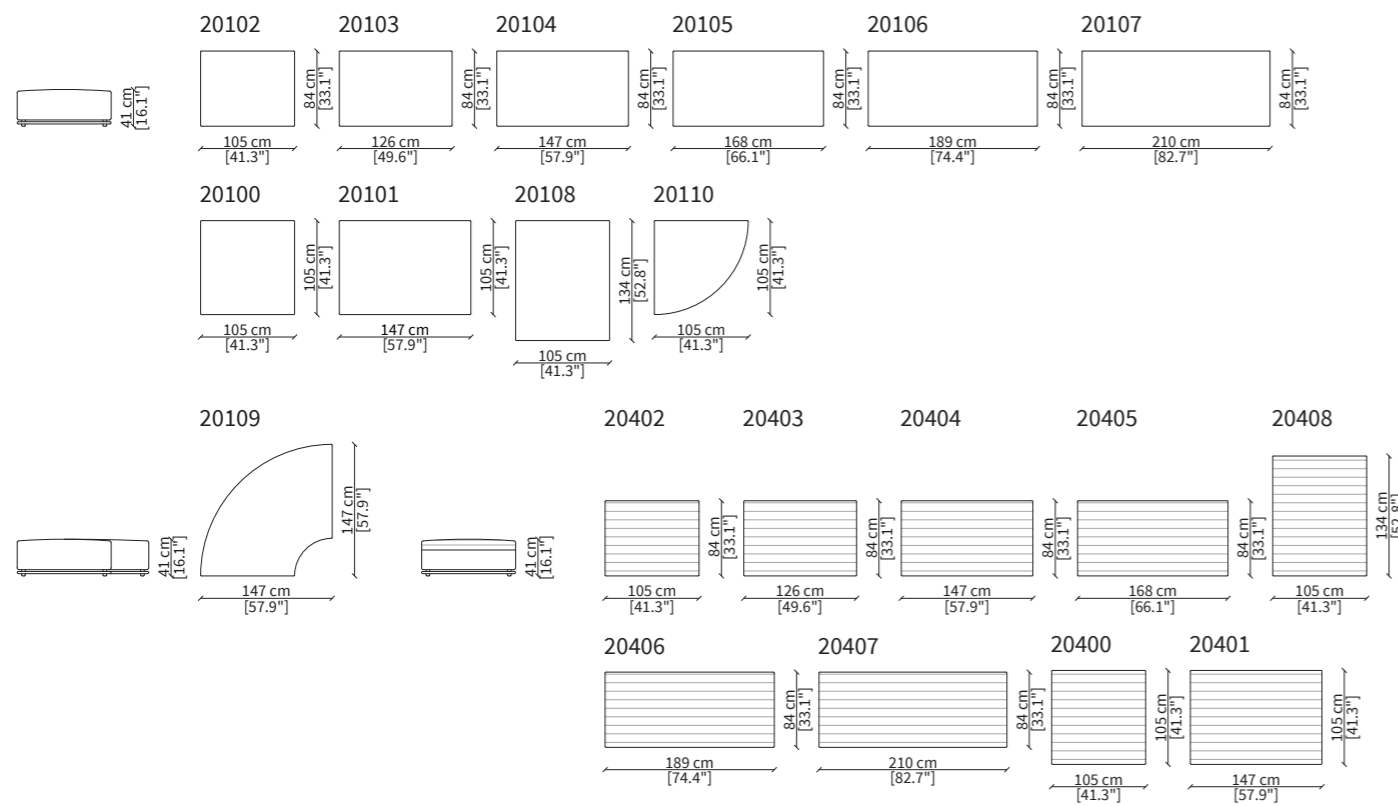

VOLUMI / VOLUMES

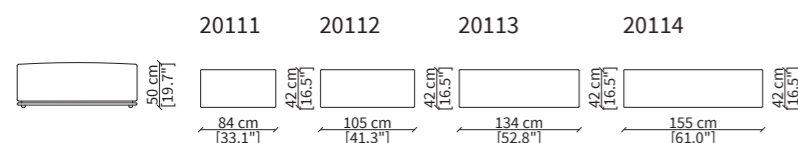

Dimensioni espresse in cm se non diversamente indicato.
 L'Azienda si riserva il diritto di apportare modifiche ai modelli senza preavviso.
 Tolleranza sulle misure indicate di +/- 2%.

Dimensions in centimeter if not differently indicated.
 The Company reserves the right to change the models without any advance notice.
 Tolerance on the given sizes +/- 2%.

EDDIE SOFA

Design R&D Frigerio

B BRACCIOLLO BASSO / LOW ARMREST / h. 59 cm

A BRACCIOLLO ALTO / HIGH ARMREST / h.71 cm



DIVANI / SOFAS

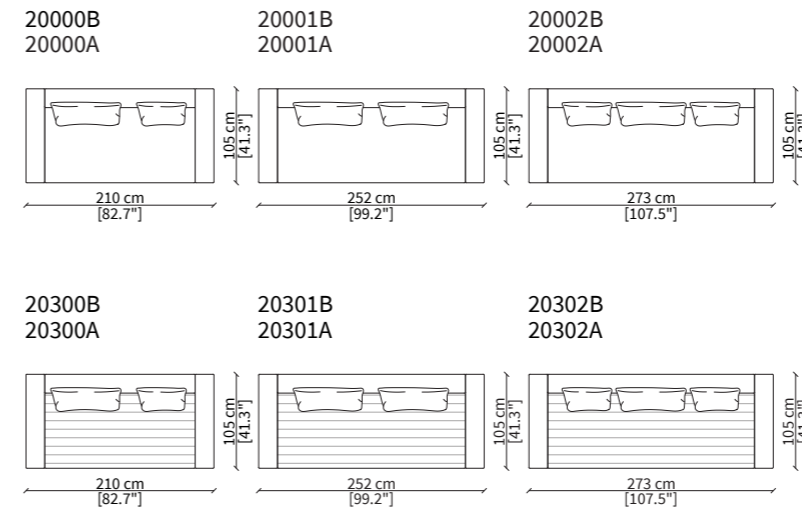

ELEMENTI TERMINALI / TERMINAL ELEMENTS

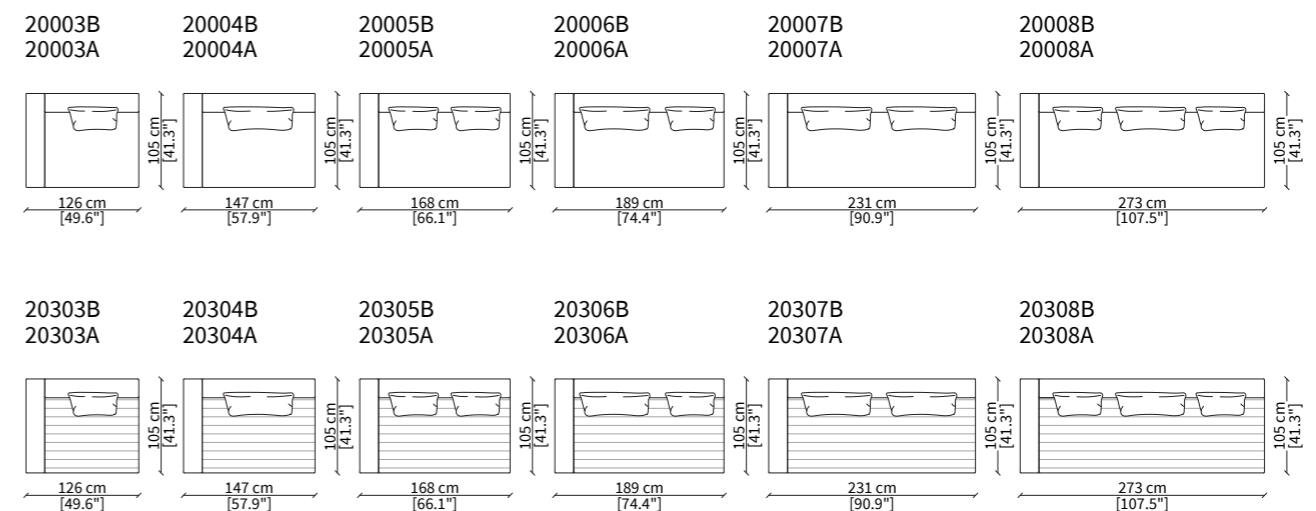

Dimensioni espresse in cm se non diversamente indicato.
 L'Azienda si riserva il diritto di apportare modifiche ai modelli senza preavviso.
 Tolleranza sulle misure indicate di +/- 2%.

Dimensions in centimeter if not differently indicated.
 The Company reserves the right to change the models without any advance notice.
 Tolerance on the given sizes +/- 2%.

EDDIE SOFA Design R&D Frigerio

ELEMENTI CENTRALI / CENTRAL ELEMENTS

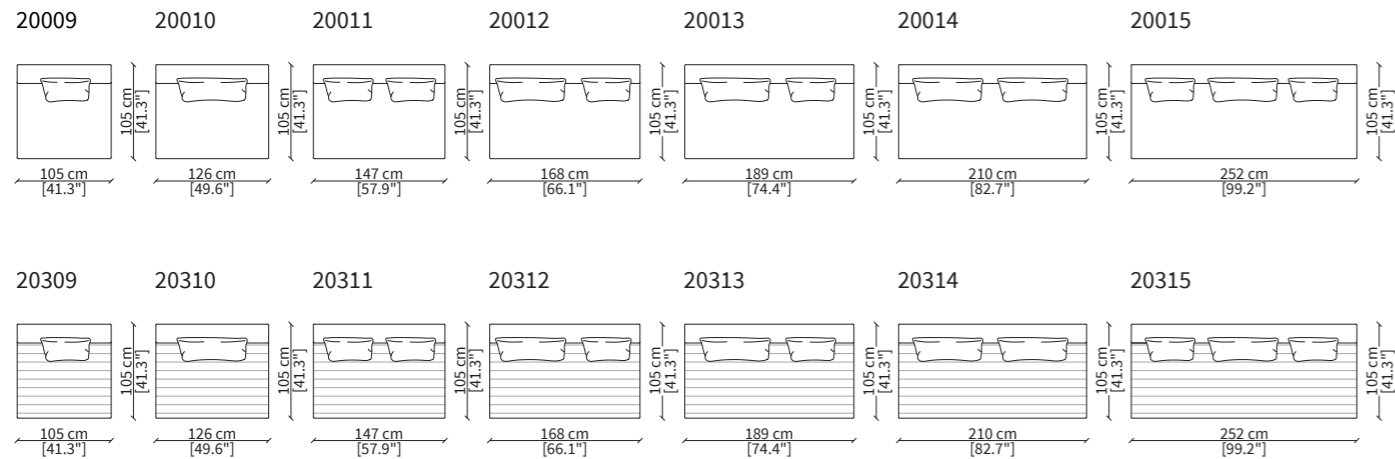

ELEMENTI DORMEUSE / DORMEUSE ELEMENTS

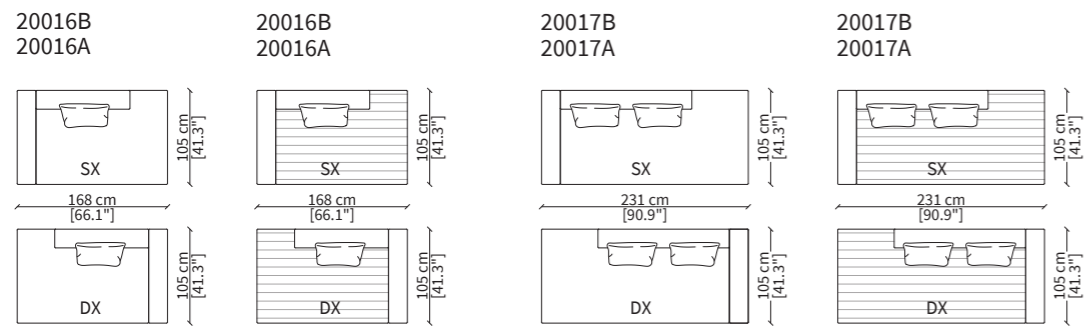

ELEMENTI CENTRALI DORMEUSE / CENTRAL DORMEUSE ELEMENTS

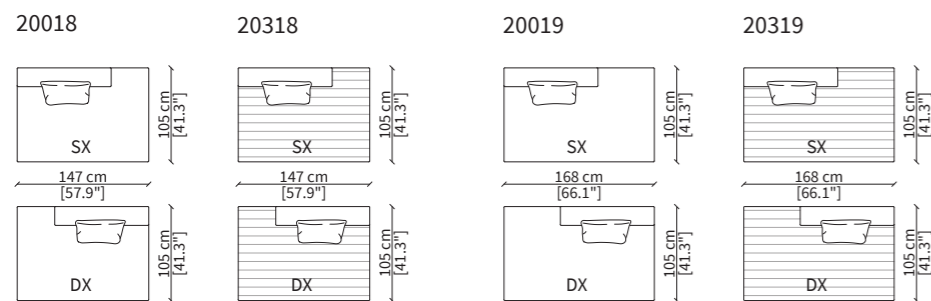

Dimensioni espresse in cm se non diversamente indicato.
L'Azienda si riserva il diritto di apportare modifiche ai modelli senza preavviso.
Tolleranza sulle misure indicate di +/- 2%.

Dimensions in centimeter if not differently indicated.
The Company reserves the right to change the models without any advance notice.
Tolerance on the given sizes +/- 2%.

EDDIE SOFA Design R&D Frigerio

CHAISES LONGUE

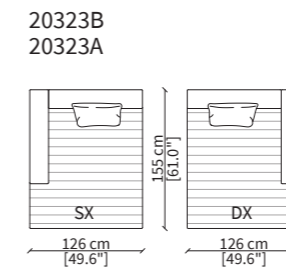
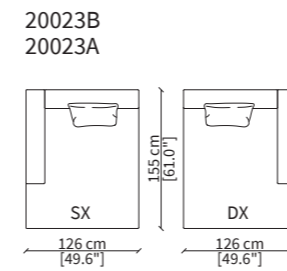

CHAISES LONGUE CENTRALI / CENTRAL CHAISES LONGUE

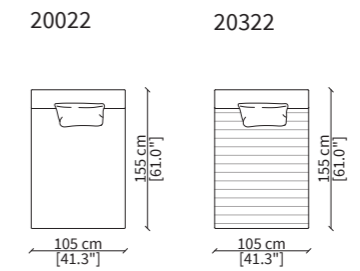

ELEMENTI TERMINALI COMFORT / COMFORT TERMINAL ELEMENTS

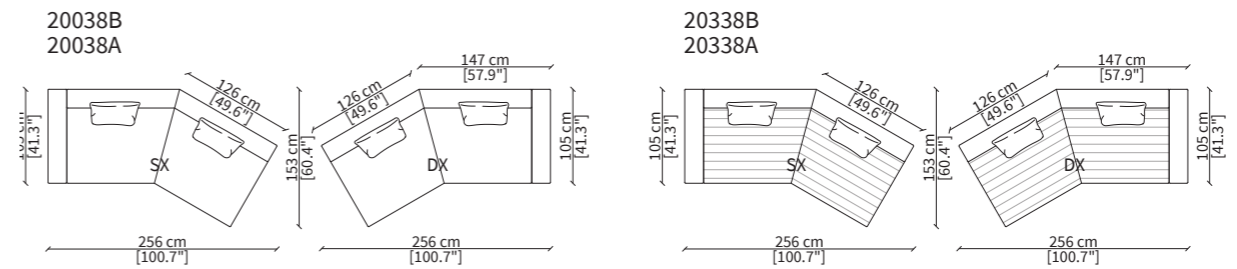

ELEMENTI CENTRALI COMFORT / COMFORT CENTRAL ELEMENTS

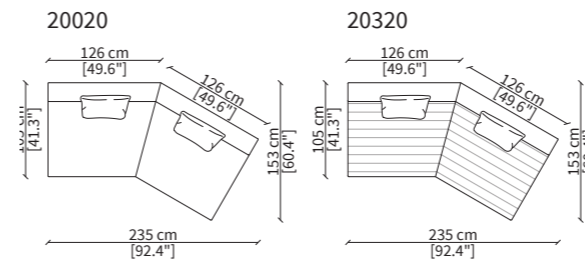

ELEMENTI DORMEUSE COMFORT / COMFORT DORMEUSE ELEMENTS

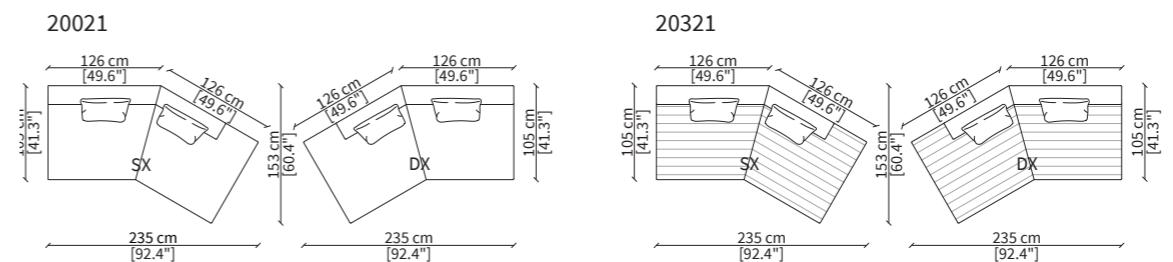

ELEMENTI ANGOLO / CORNER ELEMENTS

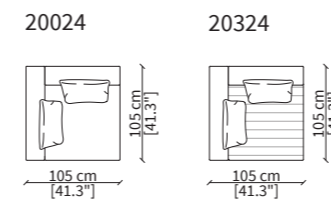

Dimensioni espresse in cm se non diversamente indicato.
L'Azienda si riserva il diritto di apportare modifiche ai modelli senza preavviso.
Tolleranza sulle misure indicate di +/- 2%.

Dimensions in centimeter if not differently indicated.
The Company reserves the right to change the models without any advance notice.
Tolerance on the given sizes +/- 2%.

EDDIE SOFA

Design R&D Frigerio

ELEMENTI SEDUTA PER EDDIE DOUBLE / SEAT ELEMENTS FOR EDDIE DOUBLE

B BRACCIOLO BASSO / LOW ARMREST / h. 59 cm

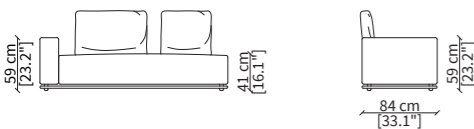

A BRACCIOLO ALTO / HIGH ARMREST / h. 71 cm

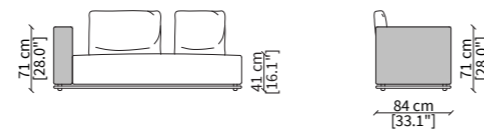

ELEMENTI SEDUTA TERMINALE / TERMINAL SEAT ELEMENTS

20025B 20026B 20027B 20028B 20029B
20025A 20026A 20027A 20028A 20029A

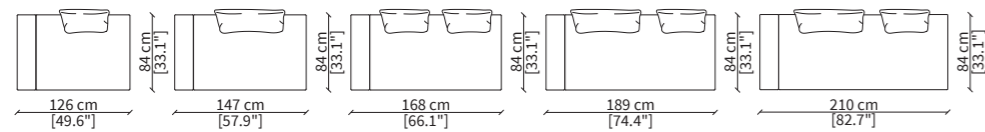

20325B 20326B 20327B 20328B 20329B
20325A 20326A 20327A 20328A 20329A

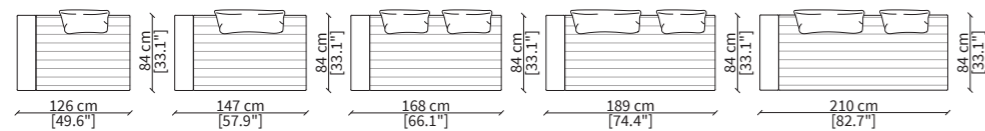

ELEMENTI SEDUTA CENTRALI / CENTRAL SEAT ELEMENTS

20030 20031 20032 20033 20034 20035

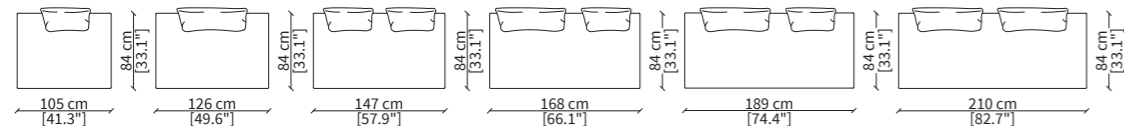

20330 20331 20332 20333 20334 20335

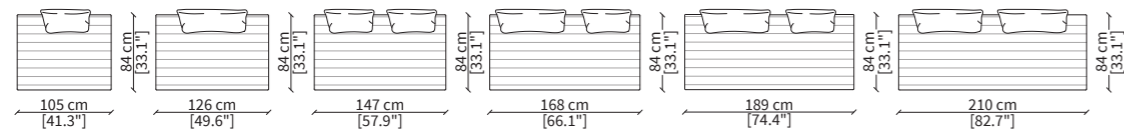

ELEMENTI SEDUTA CHAISE LONGUE / CHAISE LONGUE SEAT ELEMENTS

20037B 20037A

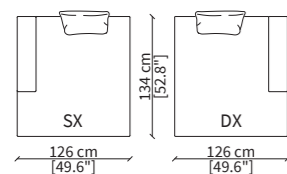

20337B 20337A

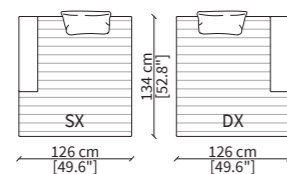

ELEMENTI SEDUTA CENTRALI CHAISE LONGUE / CENTRAL CHAISE LONGUE SEAT ELEMENTS

20036 20036

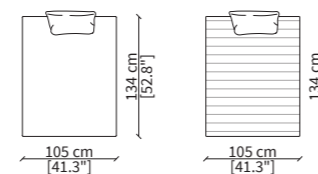

Dimensioni espresse in cm se non diversamente indicato.
L'Azienda si riserva il diritto di apportare modifiche ai modelli senza preavviso.
Tolleranza sulle misure indicate di +/- 2%.

Dimensions in centimeter if not differently indicated.
The Company reserves the right to change the models without any advance notice.
Tolerance on the given sizes +/- 2%.

EDDIE SOFA

Design R&D Frigerio

ESEMPI DI COMPOSIZIONE AD ANGOLO CON BRACCIOLO BASSO / EXAMPLES OF CORNER COMPOSITIONS WITH LOW ARMREST

Le composizioni ad angolo possono essere così realizzate:
Corner composition can be built as follows:

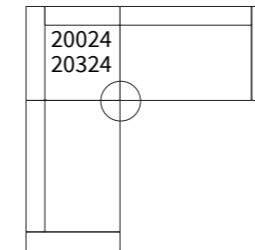

1. utilizzando l'angolo (art. **20024** o **20324**) per un allineamento preciso delle sedute.

1. by using the corner (art. **20024** or **20324**) for a perfect alignment of the seats.

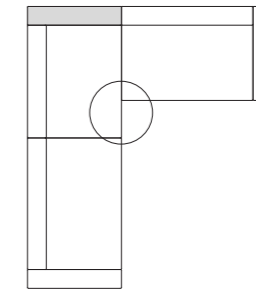

2. utilizzando un terminale con bracciolo alto per creare un angolo. Sugeriamo l'aggiunta di un cuscino schienale per maggior comfort.

2. by using a terminal with high armrest to create a corner. We recommend adding an extra back cushion for a better comfort.

ESEMPI DI COMPOSIZIONE AD ANGOLO CON BRACCIOLO ALTO / EXAMPLES OF CORNER COMPOSITIONS WITH HIGH ARMREST

Le composizioni ad angolo possono essere così realizzate:
Corner composition can be built as follows:

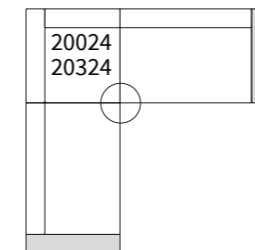

1. utilizzando l'angolo (art. **20024** o **20324**) per un allineamento preciso delle sedute.

1. by using the corner (art. **20024** or **20324**) for a perfect alignment of the seats.

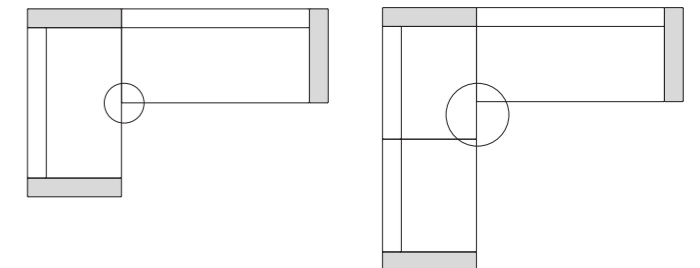

2. accostando tra loro gli elementi con bracciolo alto. Sugeriamo l'aggiunta di un cuscino schienale per maggior comfort.

2. by combining the elements with high armrest. We recommend adding an extra back cushion for a better comfort.

Dimensioni espresse in cm se non diversamente indicato.
L'Azienda si riserva il diritto di apportare modifiche ai modelli senza preavviso.
Tolleranza sulle misure indicate di +/- 2%.

Dimensions in centimeter if not differently indicated.
The Company reserves the right to change the models without any advance notice.
Tolerance on the given sizes +/- 2%.

EDDIE SOFA
Design R&D Frigerio

COMPOSIZIONE 1 / COMPOSITION 1

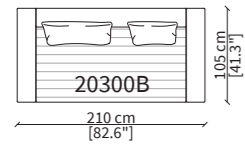

CODICI / CODES: **20300B**

COMPOSIZIONE 2 / COMPOSITION 2

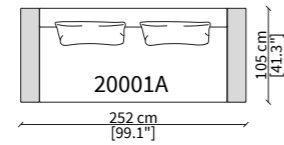

CODICI / CODES: **20001A**

COMPOSIZIONE 3 / COMPOSITION 3

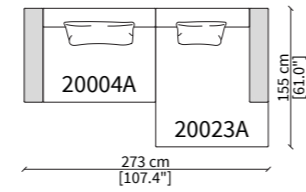

CODICI / CODES: **20004A, 20023A**

COMPOSIZIONE 4 / COMPOSITION 4

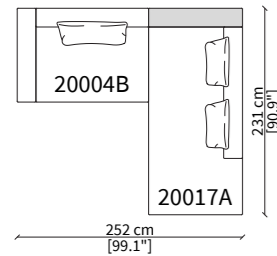

CODICI / CODES: **20004B, 20017A**

COMPOSIZIONE 5 / COMPOSITION 5

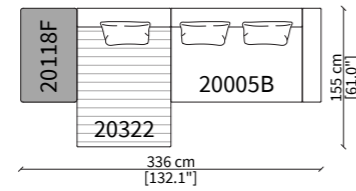

CODICI / CODES: **20118F, 20322, 20005B**

COMPOSIZIONE 6 / COMPOSITION 6

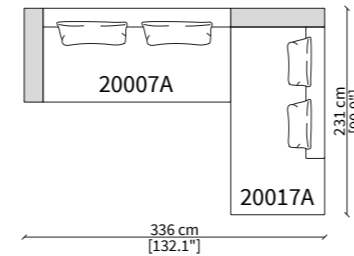

CODICI / CODES: **20007A, 20017A**

COMPOSIZIONE 7 / COMPOSITION 7

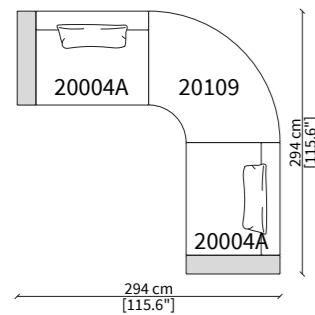

CODICI / CODES: **20004A x 2, 20109**

COMPOSIZIONE 8 / COMPOSITION 8

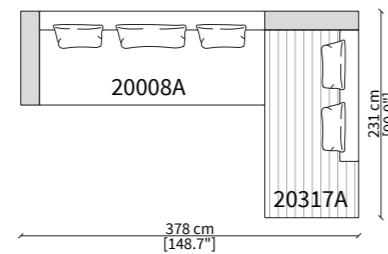

CODICI / CODES: **20008A, 20317A**

COMPOSIZIONE 9 / COMPOSITION 9

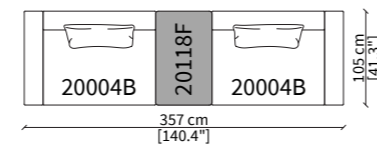

CODICI / CODES: **20004B x 2, 20118F**

Dimensioni espresse in cm se non diversamente indicato.
L'Azienda si riserva il diritto di apportare modifiche ai modelli senza preavviso.
Tolleranza sulle misure indicate di +/- 2%.

Dimensions in centimeter if not differently indicated.
The Company reserves the right to change the models without any advance notice.
Tolerance on the given sizes +/- 2%.

EDDIE SOFA
Design R&D Frigerio

COMPOSIZIONE 10 / COMPOSITION 10

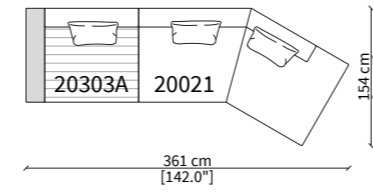

CODICI / CODES: **20303A, 20021**

COMPOSIZIONE 11 / COMPOSITION 11

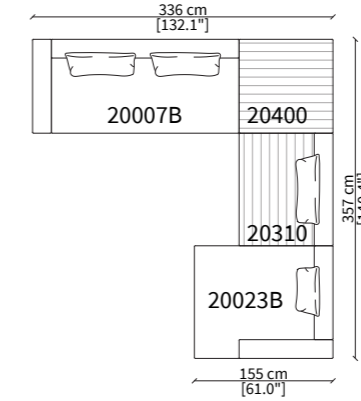

CODICI / CODES: **20007B, 20400, 20310, 20023B**

COMPOSIZIONE 12 / COMPOSITION 12

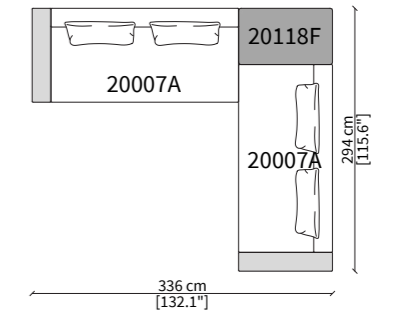

CODICI / CODES: **20007A x 2, 20118F**

COMPOSIZIONE 13 / COMPOSITION 13

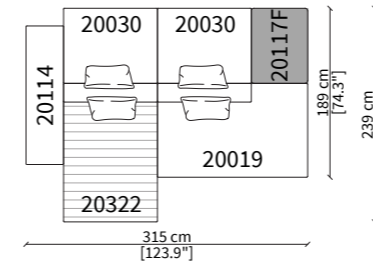

CODICI / CODES: **20114, 20030 x 2, 20117F, 20322, 20019**

COMPOSIZIONE 14 / COMPOSITION 14

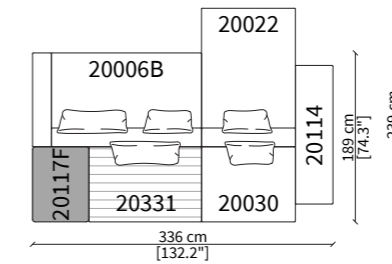

CODICI / CODES: **20006B, 20022, 20114, 20117F, 20331, 20030**

COMPOSIZIONE 15 / COMPOSITION 15

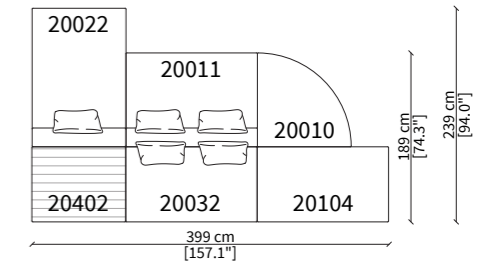

CODICI / CODES: **20022, 20011, 20010, 20402, 20032, 20104**

COMPOSIZIONE 16 / COMPOSITION 16

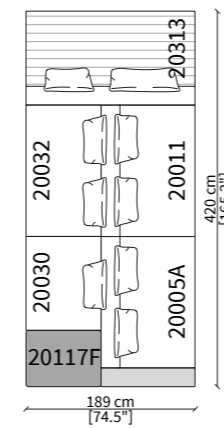

CODICI / CODES: **20117F, 20030, 20032, 20005A, 20011, 20313**

COMPOSIZIONE 17 / COMPOSITION 17

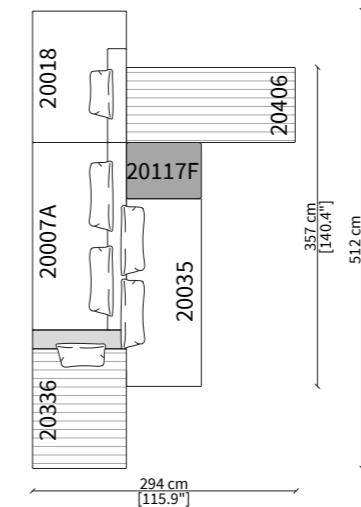

CODICI / CODES: **20336, 20007A, 20018, 20035, 20117F, 20406**

COMPOSIZIONE 18 / COMPOSITION 18

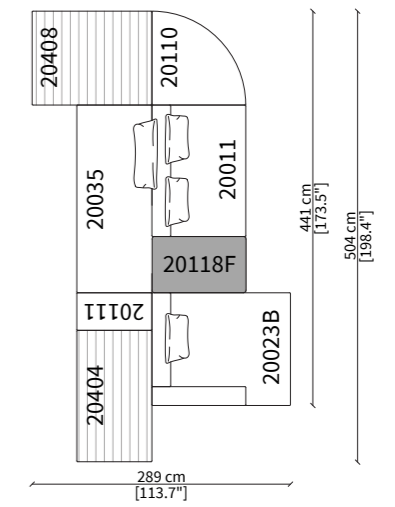

CODICI / CODES: **20404, 20111, 20035, 20408, 20023B, 20118F, 20011, 20110**

Per la gamma completa di materiali è possibile consultare il nostro sito web www.frigerio.com
The full range of materials can be found on our website at www.frigerio.com.

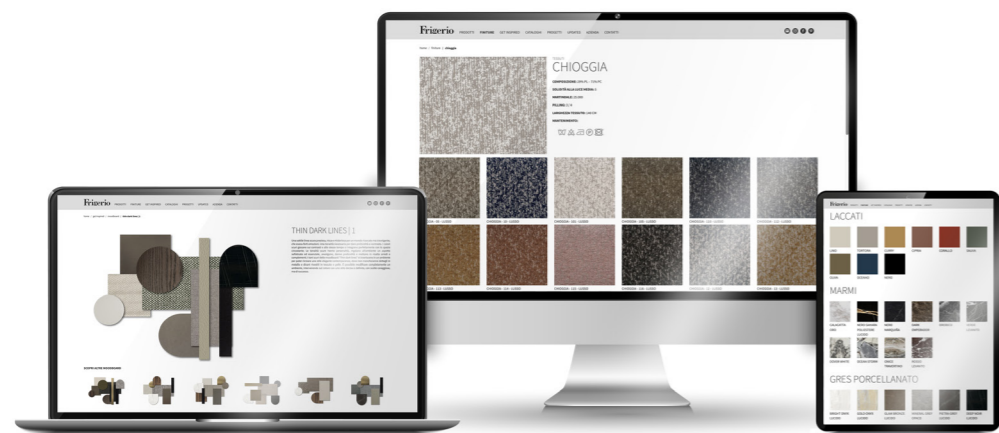

WWW.FRIGERIO.COM

Frigerio

Via Sant'Agata 63
22066 Mariano Comense (CO) - Italy
Tel. +39 031 5481225
info@frigerio.com
www.frigerio.com